

# Optimization of Material Handling Trolley using Finite Element Analysis

**Ganesh D Chavan<sup>1</sup>, Adik Yadao<sup>2</sup>**

Department of Mechanical Engineering (CADME)  
G.H.Raisoni College Of Engineering And Management,  
Pune, India

## ABSTRACT

*The purpose of this work is to develop the material handling trolleys using finite element analysis and validate the design. The main area of focus in this project is to reduce the weight and cost of the trolleys by designing a new development design. The existing trolley designed by the industry uses heavy trolleys without considering loading conditions which in turn leads to a higher factor of safety increasing the overall cost of the Trolleys.*

*This work presents a finite element analysis of a procedure to model and simulate trolleys used in the automotive parts supplier industry, especially in car component manufacturing companies for shifting or transporting the different parts. In this study, the design is carried out using CATIA software, Pre-processing work such as meshing and setting static loading condition has been set up in Hypermesh and static analysis of the trolley is performed using finite element software ABAQUS. The Von-mises yield principle has been used to determine the distribution of stress intensity. The proposed model has better results consider the existing model of the trolley.*

**Broad Academic Area of Work:** Finite Element Analysis (FEA)

**Keywords:** FEA, Material Handling trolleys, Static analysis, Von-mises stresses.

## 1. INTRODUCTION

Conventional trolleys are made with some standard dimensions by the vender, so there is a lot of scope of improvement in the design of trolley according to our requirement. That will not only reduce the cost of trolley but also create more space in the inventory or vehicle that carrying product in the trolley if we modify the design to optimum level, so for that main area of work is creating different new designs of trolley and check for following factor that are important for any product improvement,

- Factor of safety
- Failure criteria of design by using FEA
- Costing.

So current project is focused on the new design of trolley and check the load carrying capacity, FOS by using FEA simulations for to get optimize design for trolley. Trolley are mostly used in industries to carry product with safety but most of the trolley are made by vender with standard dimensions with lot of factor of safety. So come up with the idea of modifying the design of trolley considering following factors.

- Cost
- Design to accommodate more product in the space

Trolley are such that they don't usually check for the design optimization and but if we check the costing of the trolleys that create space for improvement, so FEA gives more pleasure to get optimize design without doing prototype

testing carries more cost. As we know in inventory we have to accommodate more product in less area so stacking is important factor for trolley, so we are checking this design for stacking load carrying capacity also. Also there is future scope in this to test this model for fatigue analysis to check if this optimize design will be able to withstand long period of time.

## 2. LITERATURE REVIEWS

A trolley is a type of vehicle that runs along the street on tracks. The trolley is used in a wide area of applications like home, office, railways, airport, hospital, resort, and construction industries and in manufacturing industries. Thus usage of trolley plays an essential function, utmost in all construction industries and manufacturing industries. The trolley is constructed according to various features like load capacity, materials, and mainly ergonomic design. The main aim of the trolley is to provide a hassle-free mode of transporting from one loading station to a different loading station. The old designs of trolleys are huge due to the reality that they require to carry loads of different magnitude. In the global competition, it is very essential for the manufacturer to develop new product designs for the market at a more rapid rate and also at a cheaper cost. development of the trolley is required to improve the weight ratio for a certain factor of safety without varying any assembly parameters. A trolley is a big base that is used to transfer the heavy parts from one place to a different place. The Trolley is passed manually over the tracks mounted on the floor.

BEHNAM POURBABI(1) has studied Each work station has local storage, a set of flexible machines capable of convert workpieces belonging to the same family of parts, and an unloading station. Each workpiece demand only one stage of operation which may receive it from either one of the workstations. The integrated material handling arrangement involves a set of line conveyors, each with a specified length, velocity, and capacity. In this paper, an open queuing network model is developed to evaluate the effects of the loading, material handling, storage, and covert operations on the asymptotic performance of the arrangement. Furthermore, a technique for controlling the congestion along the material handling arrangement is suggested. Numerical results also contribute and the results of the approximation are compared against those from a simulation study.

RAMKUMAR(2) has studied Finite element analysis of trolley was carried out to optimize and validate the design. To design a trolley, a design method is proposed. The design method leads to good results in a shorter time. In this study, the design is carried out using CREO software, and analysis of the trolley is performed using finite element commercial code ANSYS Workbench. The Von-mises yield principle has been used to determine the distribution of stress severity. The proposed model has better results compared to the existing model of the trolley by means of reducing the weight of the structural design of the base welded structure which is directly transferred to the wheel.

## 3. METHODOLOGY

Following methodology has been adapted to carry out optimization of trolley. To implement design of trolleys by using finite element method significant literature study need to be study, so after studying the literatures, the basic things that need to be focus on is the existing design area that need to be concentrated. Taking some ideas from literatures to implement the trolleys to best.

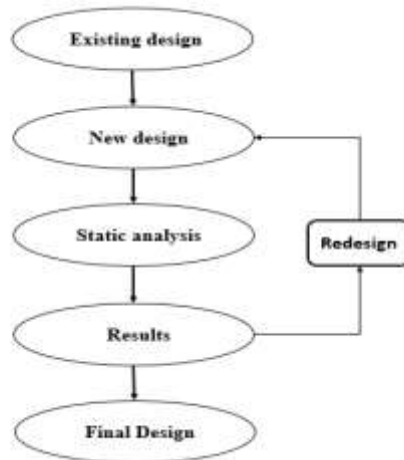

First the existing design which is not failing in the current loading condition so that is checked for factor of safety which is turn out to be lot more. So the area of focus is mainly to optimize design such that it will reduce the cost and weight of the trolley as well as at the same time increase the material handling capacity of the trolley.

#### 4. DESIGN/IMPLEMENTATION/MODELING

##### 4.1 Linear static analysis

In static analysis load acting of the trolley is constant throughout the time period. Also material behavior is linear so linear static analysis is carried out for the trolley. Finite element analysis consists of creating mesh from the geometry, assigning the material properties, defining loading and boundary conditions and finally defining the analysis load step. So after doing the analysis this will gives us the displacement and stresses in the model. All the details of it are elaborated further.

Following factor are important to understand while doing static analysis

- Geometry
- Finite element modeling (Meshing)
- Material properties
- Load and boundary conditions

##### 4.1.1 Geometry

Existing trolley dimensions are: 1877\*1082\*1250mm (LBH) which were design with some standard dimensions and considerations, which were directly purchased from the vendor. So in new designs there will be a consideration to reduce the unnecessary factors.

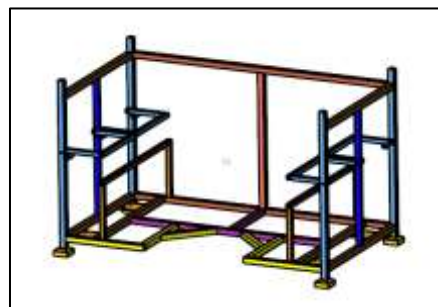

Fig 1 – Existing trolley design

Design is made in catia V5. Weight of the existing trolley is 109 Kg which is observe to be heavy looking at the application so there is scope of optimization that will be shown ahead. Also this design used for little different application and currently we are modifying it for one specific application. There is no geometric nonlinearity in the model so while doing FEA its considered as linear.



Fig 2 – Meshed existing model

1.3) Material properties

Material used is Carbon steel and material is considered as linear so linear properties are taken into consideration while analyzing the model. Material properties are shown below

Material	Young’s Modulus [MPa]	Poisson’s ratio	Density [Ton/mm3]	Yield strength [MPa]
Carbon steel IS 4923 240	2.1*e+5	0.3	7.85*e-9	240

Table 1 – Material properties

4.1.4 Load and Boundary conditions

It is very important to assign right load and boundary condition while doing finite element analysis otherwise result we will get will not be anywhere near to the actual result that we are willing to obtain and so we will not able to conclude accurate output of any analysis. Load acting on trolley is calculated and it is 1.07N acting vertically downwards on the faces shown in Fig 3 as the load is distributed on upper face of support. The structure is kept fixed at shown locations in Fig 4

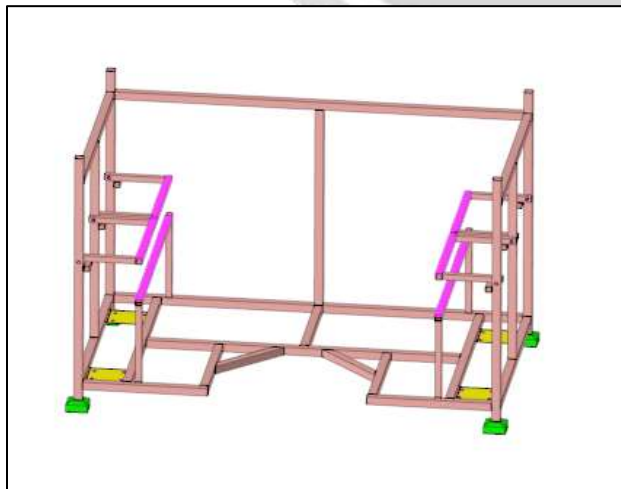

Fig 3 - Load

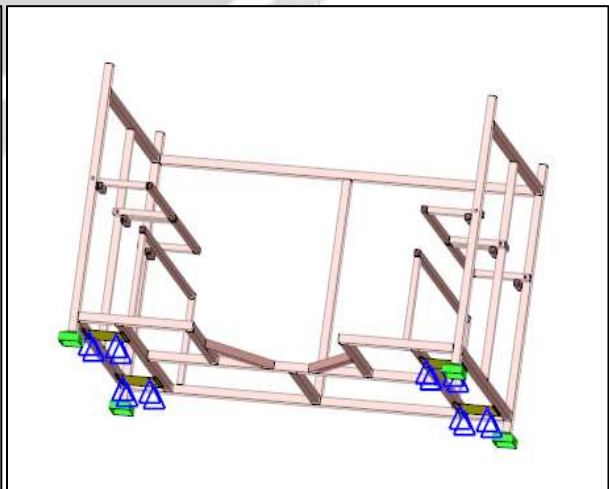

Fig 4 – Boundary condition

#### 4.1.5 Result of Existing model.

Deflection and stresses are calculated and are shown in below figures.

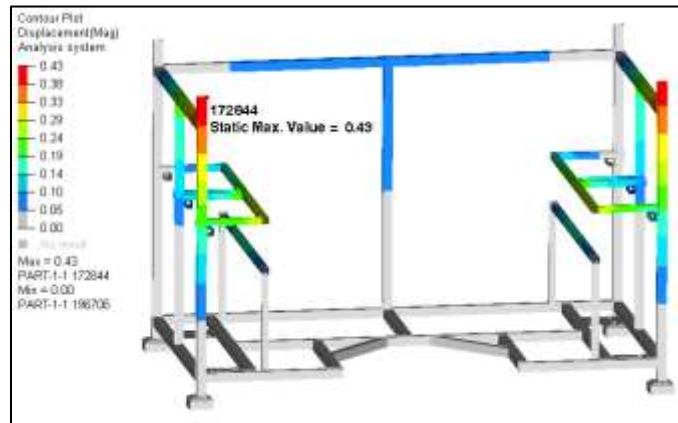

Fig 5 - Displacement

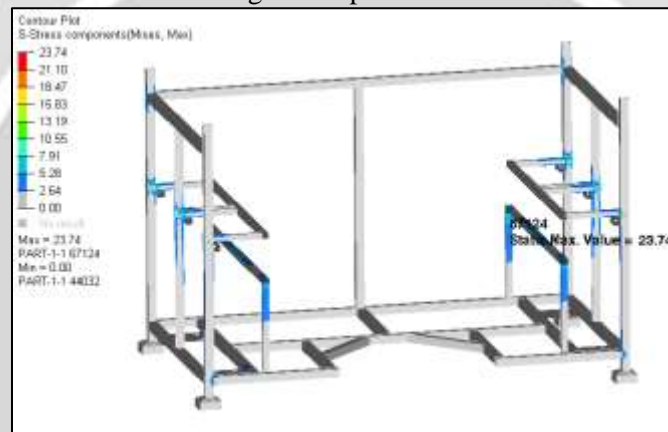

Fig 6 - Stress distribution (Von-mises)

It has been observed that for the applied loading condition there is very negligible deformation as shown in Fig 1. Stresses occurred in the model are very low as shown in Fig 2. i.e. 23.74MPa < 240MPa less than the yield limit of the material so there is lot of factor of safety in this so we can definitely optimize the design. Also there are region other than the welding and bolt locations where stresses are very less so there is opportunity in that region for the optimization. Considering these factors new designs are made and check if they are ok for the application. New designs and their result are shown ahead.

#### 4.2 Redesign

While redesigning the trolley points mention above that are weight and factor of safety are taken into consideration. Also the areas where stresses are negligible that areas are focused while redesigning. There are 4 new cases are made and they all are analyzed. Case by case its shown below.

##### 4.2.1 Case 1

As we can observe in existing design space inside the trolley is less utilized to 1<sup>st</sup> thing was taken into consideration was area inside trolley need to be utilize to maximum to accommodate more material/parts inside trolley. So the supporting elements of the trolley are redesigned while pipe size i.e. thickness in kept same. Weight of the new design is 94 kg.

While redesigning another thing that is taken into consideration is stacking load, because it important factor while redesigning the model with long term aspect taken into consideration. As you can see in fig 8 stacking load is applied



at the top face of the vertical pipe. Stacking load is calculated by considering same designs have kept up and load is 1570N (160kg).

Without stacking

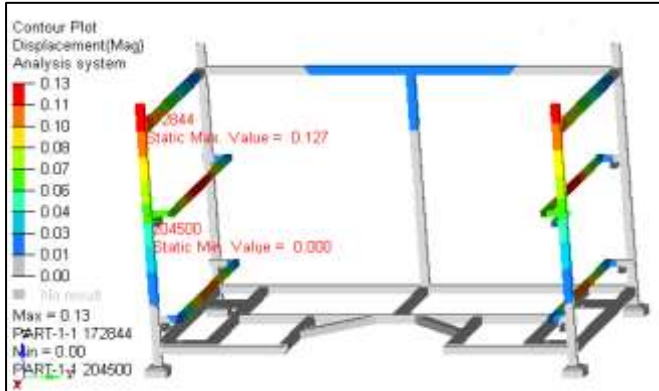

Fig 7 – Case 1\_Displacement plot without stack

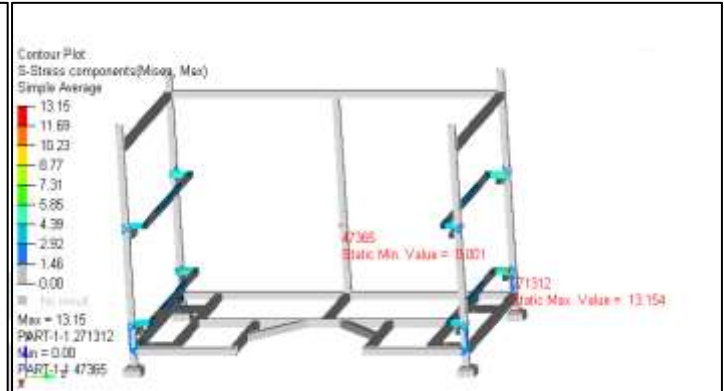

Fig 08 – Case 1\_Stress plot without stacking

Fig 10 – Case 1\_Stress plot without stacking

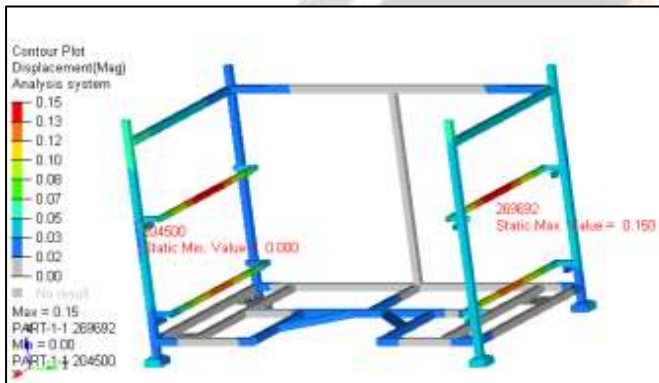

Fig 09 – Case 1\_Displacement plot with stacking

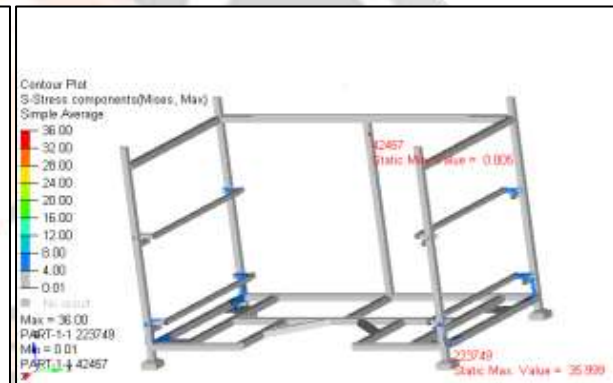

Fig 10 – Case 1\_Stress plot with stacking

Observing the result from case 1, displacement is negligible around maximum of 0.15mm and stress is maximum of 36 MPa with stacking and they are observed at bolting locations. So there is still scope of improvement in weight point of view.

#### 4.2.2 Case 2

In case 2 thickness of the pipe is changed and it is reduced to 2 mm from 3mm by looking at the availability of the 2mm size pipe it has chosen. Weight of this design is reduced to 66.3 kg

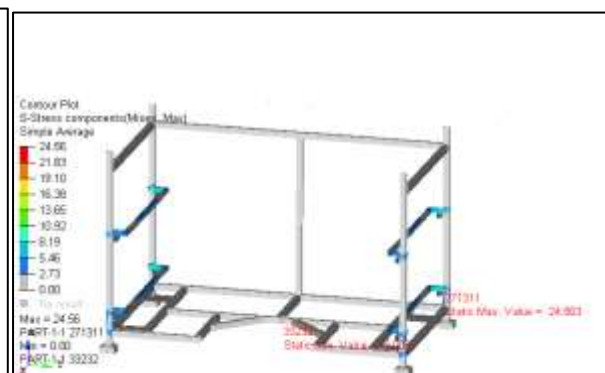
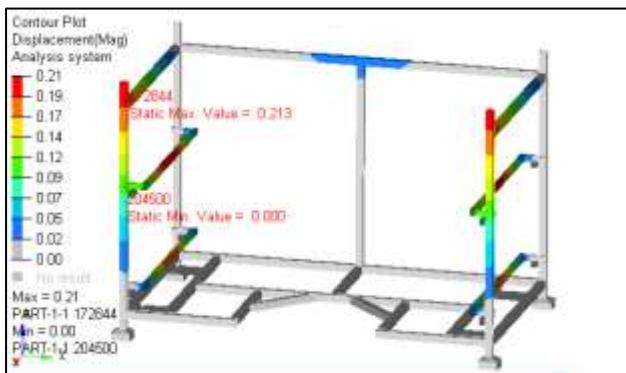

Fig 15 – Case 2\_Displacement plot without stacking

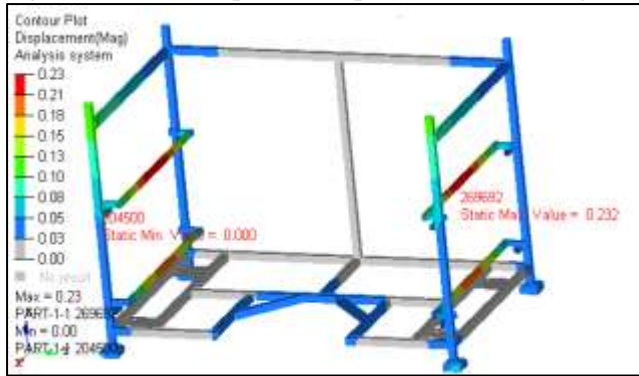

Fig 16 – Case 2\_Stress plot without stacking

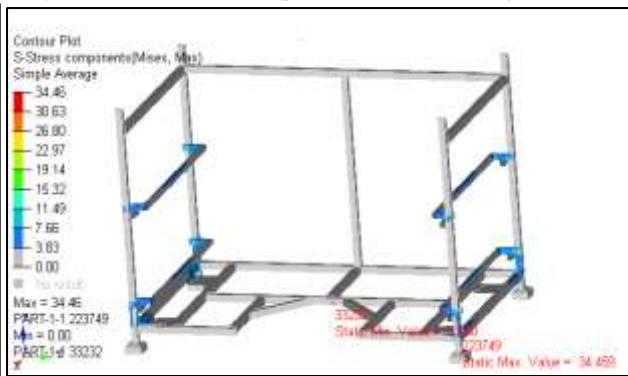

Fig 17 – Case 3\_Displacement plot with stacking

Fig 18 – Case 2\_Stress plot with stacking

By looking at the result from case 2 in both the models displacement is still negligible i.e. max 0.23mm and stress are maximum of 34.46 MPa amongst both models. Stresses are still at bolt locations.

### 4.2.3 Case 3

In this model by looking at the availability of the pipe size, 1.2mm pipe size has been selected. And the weight of the model is reduced to 44 kg.

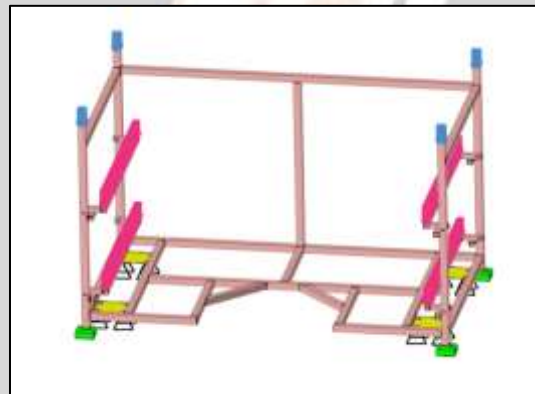

Fig 19 – Case 3\_Load and boundary condition

### Results without stacking

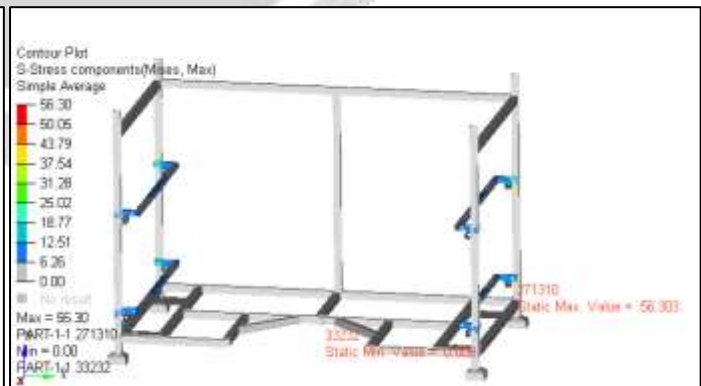
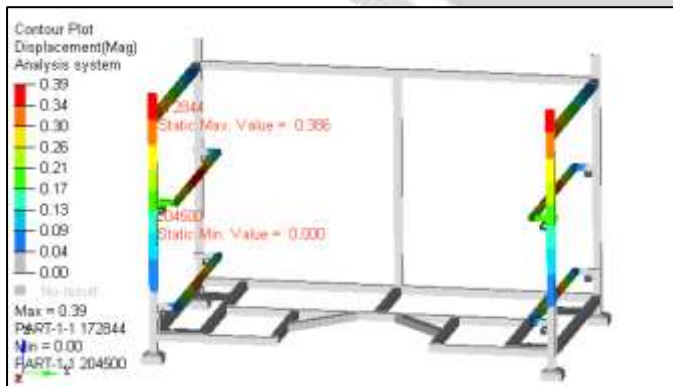

Fig 20 – Case 3\_Displacement plot without stacking

Fig 21 – Case 3\_Stress plot without stacking

### With stacking

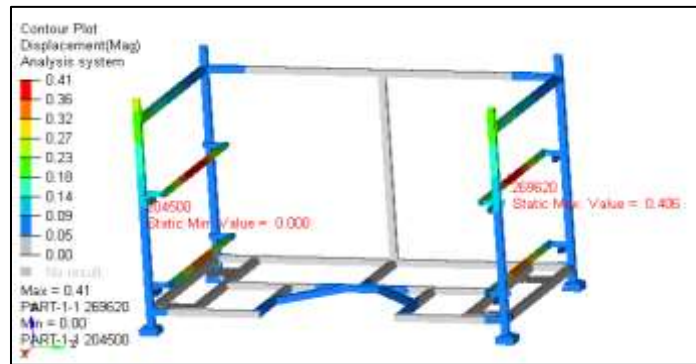

Fig 22 – Case 3\_Displacement plot with stacking

In this model we can observe that the displacement is still negligible and max is 0.41mm also the stresses are amongst the both models are still considerably within the limit and it shows max stress is 61.34 MPa. The location of stress is area near bolt. Also if still we can reduce the thickness but size of the pipe we require should be available, so we are keeping it to 1.2mm size only.

#### 4.2.4 Case 4

Another different model is tried and in this model tried to reduce weight from less stressed regions. This model was tried based on case 1 where the weight of case 1 was 94 kg this model has been reduced to 84 kg. thickness of the pipe was kept same as 3mm and tested this model with FEA. Model and result are shown below.

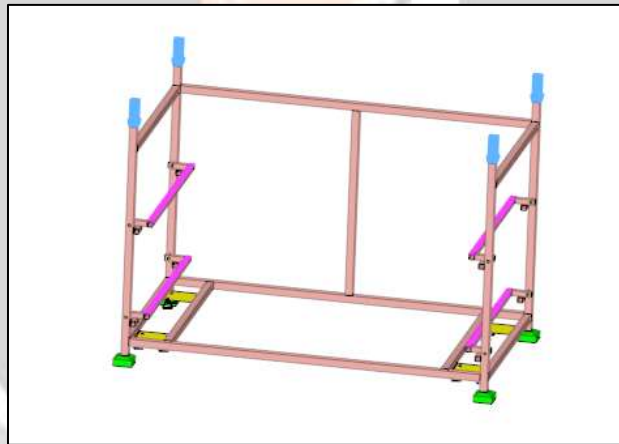

Fig 24 – Case 4\_Load and boundary condition

#### Result without stacking

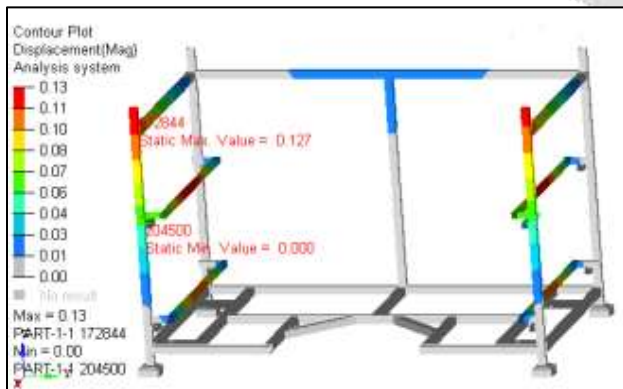

Fig 25 – Case 4\_Displacement plot without stacking

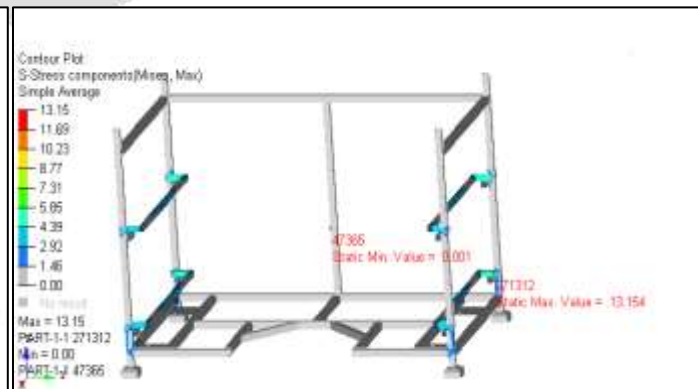

Fig 26 – Case 4\_Stress plot without stacking



With stacking

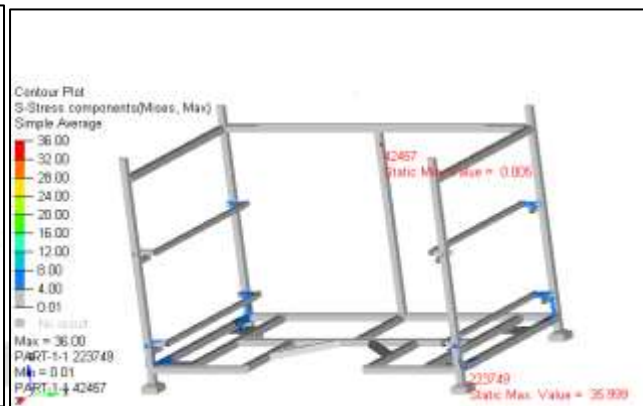
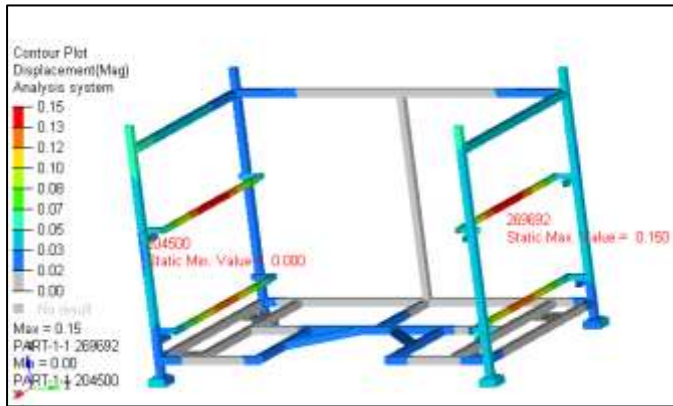

Fig 27 – Case 4\_Displacement plot with stacking

Fig 28 – Case 4\_Stress plot with stacking

By looking at the results of all models case 3 seems more optimize according to the requirements. Also the element size chosen for meshing is 5 mm so according to that mesh size we are getting all above result but in FEA it is important to get accurate results so by changing the element size we need to see if there is any change in the results so we will be doing mesh sensitivity analysis of the most optimized model so we get result accuracy of require model i.e. case 3 model.

#### 4.2.5. Mesh sensitivity analysis of case 3 model

Mesh sensitivity analysis is carried out to see if there is any change in result by the mesh size or we can say how much is the least element size, beyond which result won't affect much even changing the element size. Earlier 5 mm element size was chosen for the meshing. In this 2.5 mm element size is taken.

Element count in this model is 128236 and node count is 128032.

#### Results

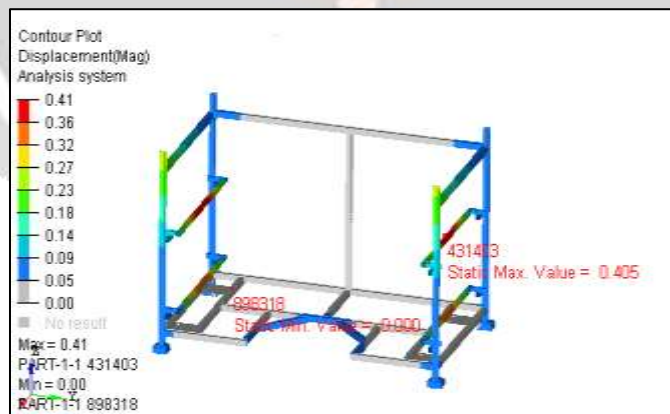

Fig 29 – Case 3\_Displacement plot with stacking\_2mm mesh.

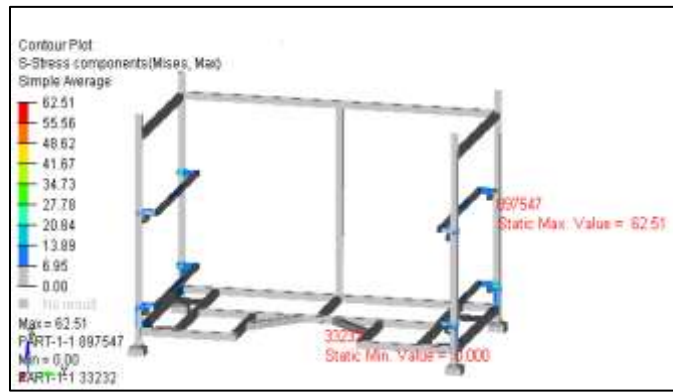

Fig 30 – Case 3\_Stress plot with stacking\_2mm mesh.

From results it has been observed that there is not much change in the results in case 3 with 5mm and 2.5 mm element size so there is no need to carry out mesh sensitivity analysis further as results are not changing much.

	Existing case	Case 1	Case 2	Case 3	Case 4
Stress (MPa)	36.1	36	34.46	62.5	35.7
Deflection (mm)	0.37	0.15	0.23	0.41	0.15
Weight (kg)	109.2	94	66.3	44	84.3
Weight reduction %	Existing	14	39.3	59.7	22.8
Inference	Not ok	Not ok	Not ok	ok	Not ok

Table 2 – Consolidated shape optimization

From above consolidated shape optimization table we can clearly see that case 3 results are better than other cases and the existing one also.

#### 4.3 Cost estimation of new design

Existing design was brought directly from the supplier so it cost one trolley for INR 16000. Now once this design is accepted by plant team then this finalized design will be manufactured in the company itself so it will reduce the cost of the trolley. So the only thing we required is material to brought, other things such as welding equipment, welder and welding material are available in the plant. So the detailed proposed cost estimation for one trolley is shown below.

Item	Cost (INR)
Square hollow pipe 46 kg	2208 (48/kg)
MS electrodes	900
Trolley wheel * 4	600
Other cost	1000
Total Cost	4708 ~ 5000

Table 3 – Proposed cost estimation per trolley

From the above proposed cost estimation, we can see that the cost for the trolley has been reduced from INR 16000 to around INR 5000. Around 68 % cost reduction is there per trolley. This design will definitely have advantage for the current application and by looking at the requirement of number of trollies this design definitely gives added advantage.

## 5. CONCLUSION

By finite element analysis design optimization and validation is carried out. In this study design and optimization methodology is used to get better result with the proposed design in short period of time. By looking at the result it clearly shows that amongst the 4 cases, case 3 design has advantage over the existing and other design models. This new optimized design can accommodate more product in the trolley than existing one so it gives more space in the inventory as well as while transporting, lead to save the cost by this. Also the fact that existing model was costly and current design proposed cost analysis shows around 68% cost reduction. So from this study using finite element analysis I can suggest the company to go with the proposed design and manufacturing method so save the cost in bigger amount.

## 6. LITERATURE REFERENCES

- [1] Happy Bansal and Sunil Kumar, Weight Reduction and Analysis of Trolley Axle Using Ansys, International Journal of Engineering and Management Research, 2(6),2012,32-36
- [2] Kaustubh V. Wankhade, and N. A. Wankhade, Design and Analysis of Transfer Trolley for Material Handling, International Journal of Innovative and Emerging Research in Engineering,2(1), Special Issue 1 MEPCON 2015
- [3] Ramkumar R, Krishnaraju A, Optimization of Material Handling Trolley using Finite Element Analysis. IOSR Journal of Mechanical and civil Engineering (IOSR-JMCE), Volume 13, Issue 6 Ver. V (Nov. - Dec. 2016), PP 137-148
- [4] Vivek A. Bandebuche<sup>1</sup>, and D. J. Tidke, Parts Handling Systems for Machine Shops of Small and Medium Enterprises, International Journal of Engineering Research and General Science, 1(2), 2013, ISSN 2091-2730.
- [5] <https://www.indiamart.com/proddetail/material-handling-trolley-1915737162.html>
- [6] <https://dir.indiamart.com/impcat/mild-steel-welding-electrode.html>
- [7] A. P. Bahale, and Dr.S.S.Deshmukh, Improving Material Handling Efficiency in a Ginning Machine Manufacturing Company, International Journal of Innovative Research in Science, Engineering and Technology, 3(3), 2014, 10180-10186