

POWER QUALITY IMPROVEMENT USING CASCADED MULTILEVEL INVERTER WITH VARIABLE LEVEL SHIFTED MODULATION

Shardendu Kumar¹, Manish Prajapati²

¹ M.tech Scholar, Department of Electrical Engg., Bhabha Engg. Research Institute, Bhopal, M.P., India

² Manish Prajapati, Department of Electrical Engg. Bhabha Engg. Research Institute, Bhopal, M.P., India

ABSTRACT

In this work, the power quality standards such as IEC 61000-3-6, IEC 61000-2-12, has been satisfied for single-phase medium voltage applications. Eleven-level Cascaded H-Bridge (CHB) converter has been proposed which has been controlled using various level shifted modulation techniques. The ER G5/4 power quality standard has been met, which has the strictest grid codes at medium voltage level. In order to achieve this goal, symmetrical CHB with variable DC Links are employed, while the converter has a low number of switching transitions. The proposed topology has been implemented using four different modulation techniques. Also the performance analysis is done to evaluate THD of the system under various grid code conditions.

Keyword: - Multilevel Inverter (MLI), Cascaded H-Bridge (CHB), Total Harmonic Distortion (THD), Pulse Width Modulation (PWM), Level shifted PWM (LSPWM), Carrier Overlap (CO).

1. INTRODUCTION

Multilevel Inverter (MLI) structure has been invented for high power and medium voltage applications for example, mills, pumps, laminators, blower, conveyers, fans, compressors etc. [1]. To obtain higher power, the basic concept of a MLI is to use semiconductor switches in series with many lower level voltage dc sources to do power conversion by blending a stair like voltage waveform [3-7]. The most common type of MLI topologies are Flying Capacitor (Fig.1), Neutral Point Clamped (Fig. 2) and Cascaded MLI (Fig.3). The MLI has many different advantages over traditional two level converters that use different Pulse width modulation techniques. Various advantages of MLI are;

- They can generate output voltages with extremely low distortion and lower dv/dt.
- They draw input current with very low distortion.
- They generate smaller common-mode (CM) voltage.
- They can operate with a lower switching frequency.

Hybrid-bridge multilevel inverter is now a day used in high power AC supplies and adjustable speed drive application. These new class of MLI finds wide application in renewable energy integration to the utility system or to harness distributed energy resources into a useable form of energy The grid connected operation with MLI for renewable resources led to grid power quality degradation. These phenomenon has been accounted through various grid codes like; IEC 61000-3-6, IEC 61000-2-12. IEC which is abbreviated for International Electro-technical Commission; has laid the standards guidance at MV, LV and HV level to system operators or owners on engineering practices, which will facilitate the provision of adequate service quality for all connected customers.

It standardizes the harmonic emission also allocation of the capacity of the system to absorb disturbances is done. IEC/TR 61000-3-6 [1] covers compatibility levels, planning levels, and methods for managing harmonics for the connection of large customers.

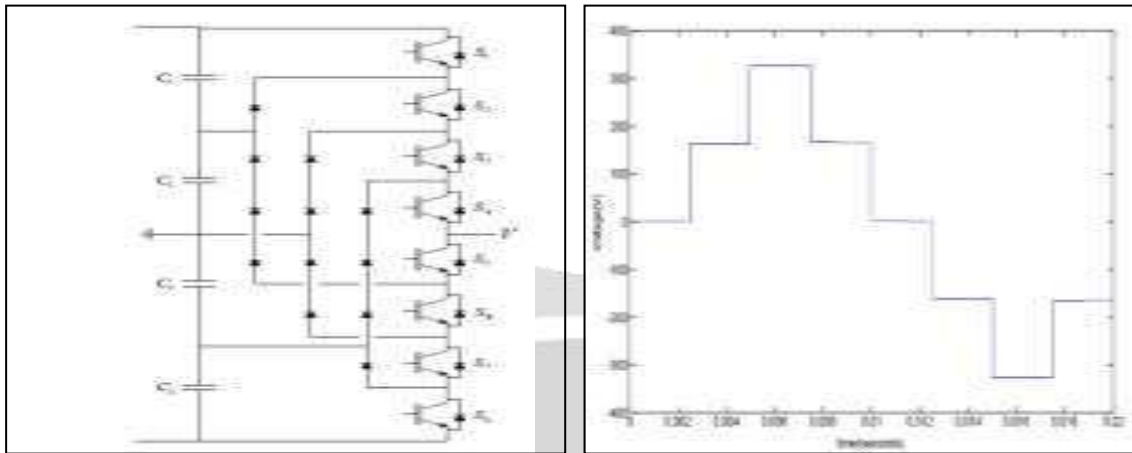

Fig. 1: Single phase 5-level Diode Clamped multilevel inverter with its output voltage waveform.

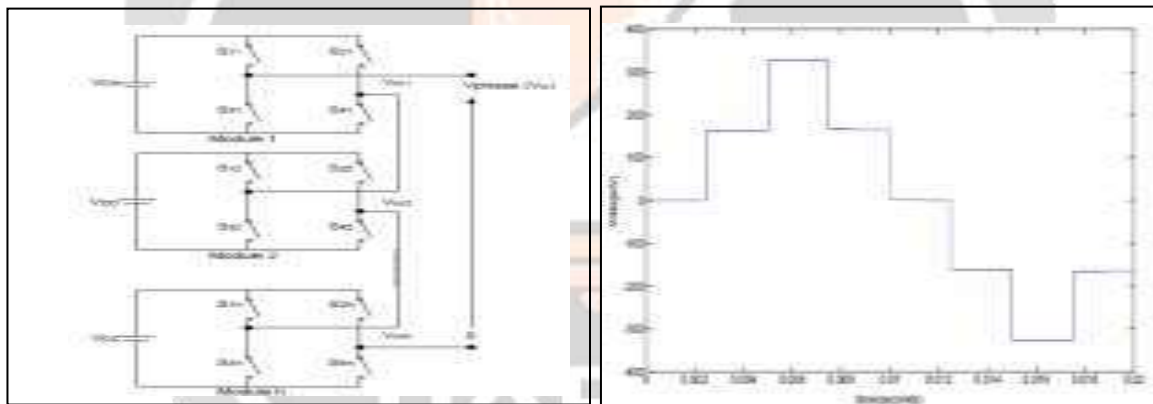

Fig. 2: Single phase 5-level Cascaded H-Bridge multilevel inverter with its output voltage waveform.

In this paper a reduced count CHBMLI is designed using total eight number of switches and three DC voltage sources to generate a 11 level multilevel inverter. The three DC voltages are connected in series with each other. The value of the DC voltage sources is V_{dc} , $2V_{dc}$ and $2V_{dc}$. That means if V_{dc} is 100Volts then the other two voltages will be 200volts. A comparison with respect to grid code for selective harmonics mitigation PWM and level shifted PWM is graphed to analyze the performance efficiency of the proposed topology of CHB-MLI.

1.1 CHBMLI WITH PULSE WIDTH MODULATION TECHNIQUES

The Cascaded H-Bridge, can also be termed as multi-cell converter, popularly used in very high power applications between 4KV to several MW, since its inherent capability of cancellation of input current harmonics [14].

CHB-MLI converters are worthy when controlled with sinusoidal PWM extended to multiple carrier arrangements of two types:

Level Shifted (LS-PWM), further classified as Phase Disposition (PD-PWM), Phase Opposition Disposition (POD-PWM) and Alternative Phase Opposition Disposition (APOD-PWM) [15], or they can be Phase Shifted (PS-PWM) [16].

In PS-PWM every carrier signal can be related to a particular and independent power cell. Hence, all the power cells operate under the similar switching conditions and therefore present an even power distribution.

But, since the carrier signals are not synchronized, the output voltage contains higher harmonic content as compared to LS-PWM.

Contrary LS-PWM are based on amplitude shifts between carrier signals, hence associated to a specific voltage level having low THD. When the reference is over one carrier, the corresponding level is generated. Therefore, when LS-PWM is used with cascaded H-bridge inverters, the cells will be used only when the corresponding level is reached, producing an uneven power distribution and switching conditions between the cells.

2. PROPOSED WORK

In the work proposed LS-PWM is developed to control the output voltage for 11-level cascaded MLI. The state-of-the-art of CHB-MLI is to design modified cascaded MLI topology with improved performance efficiency and reduced component count. The designed CHB-MLI is tested for various LS-PWM techniques. The techniques used in this work are In-phase disposition (IPD), Alternate phase Opposition disposition (APOD), Carrier Overlap (CO) and variable frequency. The designed MLI has been verified under linear loading for single phase to meet the grid codes and various IEC standards for harmonics as shown in Table- 1.

Voltage Harmonic	International Standards	
	IEC 61000-3-6 1996 1 to 35 kV	IEC 61000-2-12 2003 1 to 35 kV
Order (h)		
3	4	5
5	5	6
7	4	5
9	1.2	1.5
11	3	3.5
13	2.5	3
15	0.3	0.4
17	1.6	2
19	1.2	1.76
21	0.2	0.3
23	1.2	1.41
27	0.2	0.2
29	1.06	1.06
31	1.01	0.97
33	0.2	0.2
35	0.91	0.83
37	0.85	0.77
39	0.2	0.2
41	0.81	0.67
43	0.78	0.62
45	0.2	0.2
47	0.73	0.55
49	0.71	0.51
THD	6.5% up to 40th	8% up to 50th

Table 1: International Standards or Guidelines [4-8]

3. SIMULATION AND RESULTS

In the proposed work a reduced count CHBMLI is designed using total eight number of switches and three DC voltage sources to generate a 11 level multilevel inverter. The three DC voltages are connected in series with each other. the value of the DC voltage sources is V_{dc} , $2V_{dc}$ and $2V_{dc}$. That means if V_{dc} is 100Volts then the other two voltages will be 200volts.

A comparison with respect to grid code for selective harmonics mitigation PWM and level shifted PWM is graphed to analyze the performance efficiency of the proposed topology of CHB-MLI. The simulation model of the system designed is presented in figure 4 and the parameters required to design the system is given in table-2.

The system designed has been tested for linear loading using level shifted PWM techniques and variable frequency PWM. The result obtained are analyzed for harmonic content and a comparative graph has been shown for higher order upto 40th harmonic. The results are compared with the selective harmonic mitigation (SHM- PWM) technique as presented in [1].

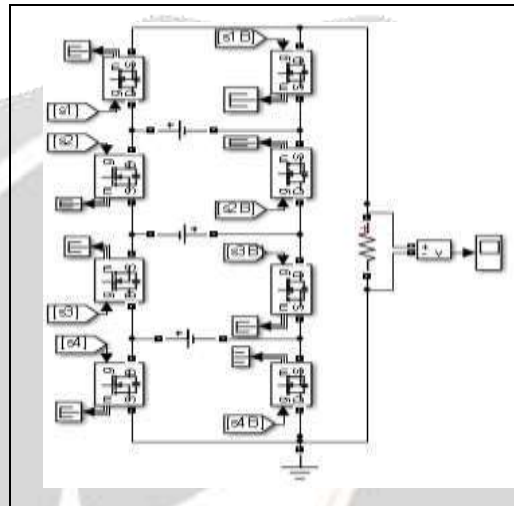

Figure 3: Single Phase CHBMLI

Components	Ratings
R load	124 ohms
switching frequency	150hz
LC filter	10^{-3} H and 10^{-6} F
frequency	50 Hz
input voltage	100 V (approx.)
Number of H-Bridge modules	3

Table 2: System Parameters

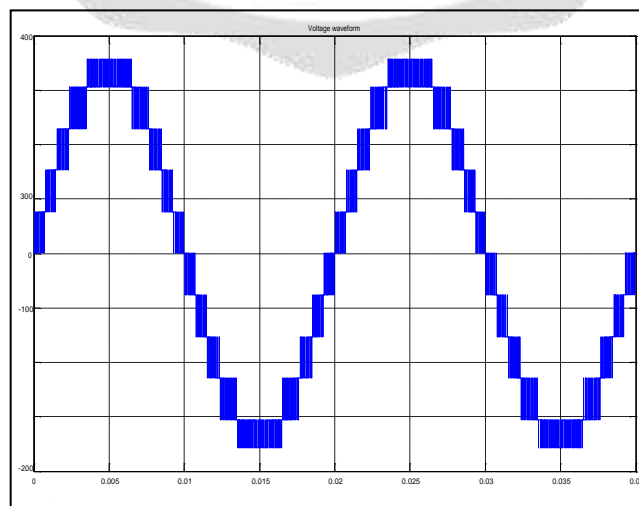

Figure 4: Output voltage of 11 level CHB-MLI for R load using IPD PWM

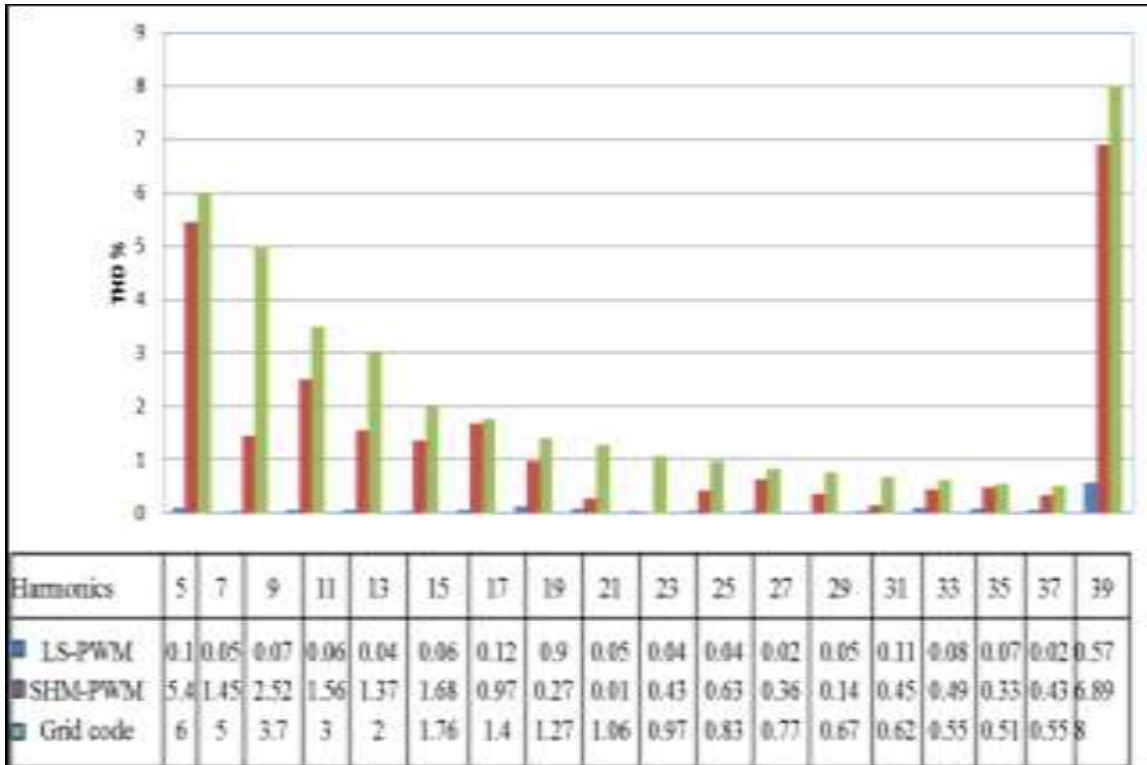

Fig. 5: Output voltage harmonic comparison for 11 level CHB-MLI for IPD PWM

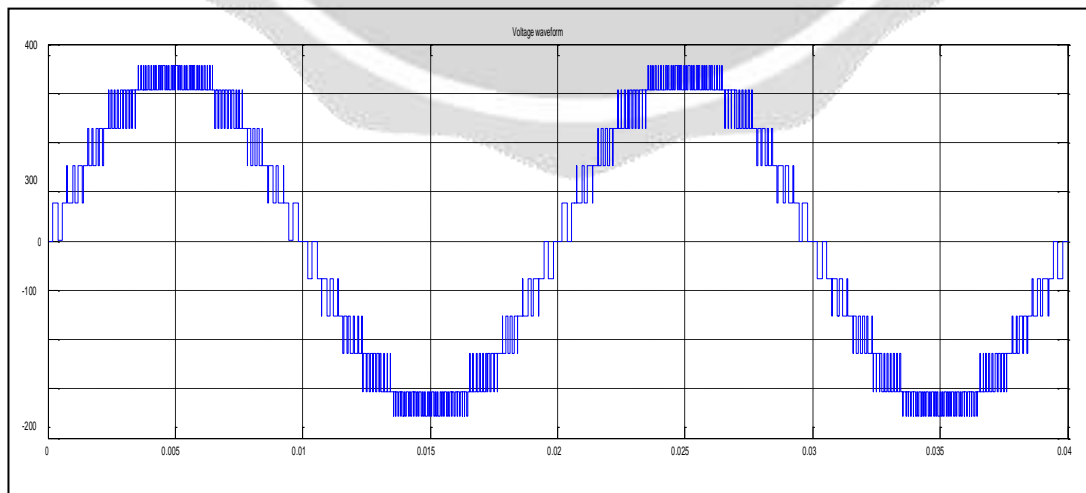

Fig. 6: Output voltage 11 level CHB-MLI for R Linear loading using VFPWM

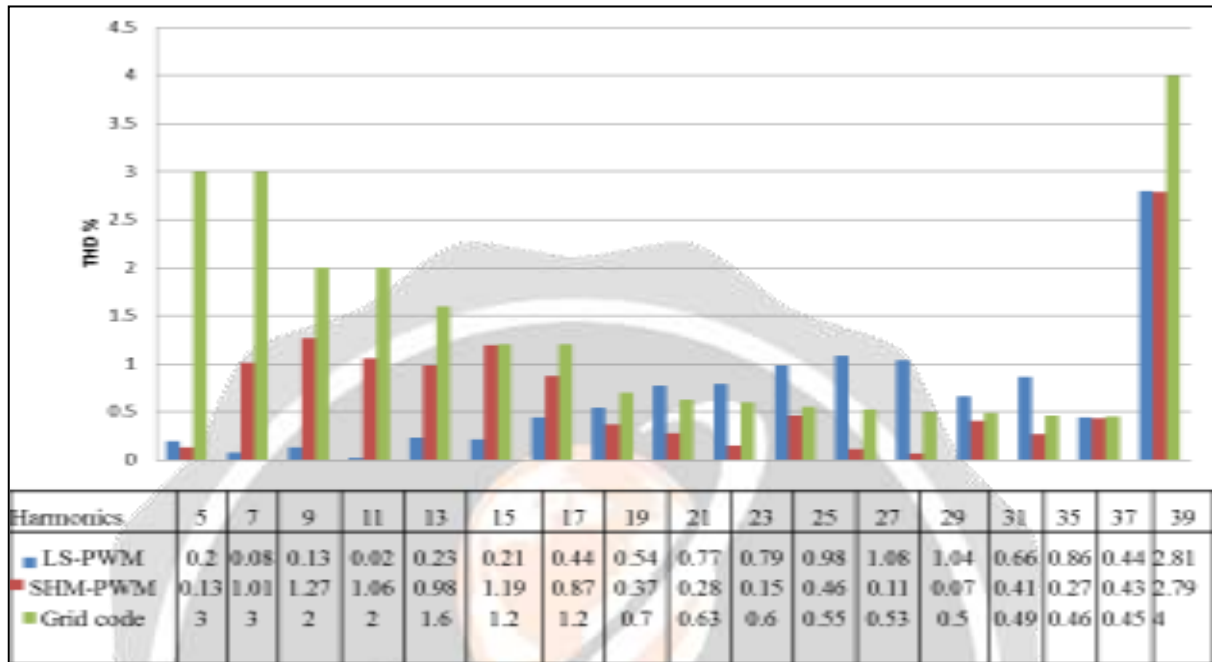

Figure 7: Output voltage harmonic comparison for 11 level CHB-MLI for linear loading using VF PWM

Level Shifted PWM techniques	Without Filter		With Filter	
	R load	RL load	R load	RL load
IPD	0.22	0.27	0.27	0.27
APOD	0.36	0.37	0.25	0.37
CO	1.80	1.81	1.80	1.81
VF	0.47	0.47	0.38	0.47

Table 3: comparison of THD for output voltage using different PWM techniques

4. CONCLUSIONS

Level shifted PWM control is implemented in this paper to design the hybrid MLI for different 11 levels at various loading conditions. It is observed that the proposed inverter has superior features compared to conventional multilevel inverters in terms of the component count, control requirements, cost, and reliability.

The efficiency of the inverter is also better as compared to conventional topologies. It is possible because of generating only positive carriers for pulse width modulation control. As the hybrid inverter requires low rated dc sources, fuel cells, photovoltaic arrays can also be used as dc sources.

5. REFERENCES

[1]. Mohammad Najjar, Amirhossein Moeini, Mohammad Kazem Bakhshizadeh, Frede Blaabjerg, Shahrokh Farhangi (2017). Optimal Selective Harmonic Mitigation Technique on Variable DC Link Cascaded HBridge

Converter to Meet Power Quality Standards Journal of Emerging and Selected Topics in Power Electronics, 117, 635-642

[2]. Buticchi, G., Concari, C., Franceschini, G., Lorenzani, E., & Zanchetta, P. (2012, September). A nine-level grid-connected photovoltaic inverter based on cascaded full-bridge with flying capacitor. In 2012 IEEE Energy Conversion Congress and Exposition (ECCE) (pp. 1149- 1156). IEEE

[3]. Nikhil Kumar, Suresh K Gawre, Deepak Verma, "Modeling and Simulation of Solar Photovoltaic System and Interfacing with Neutral Point clamped Multilevel Inverter", International Conference in Electrical, Electronics and Computer Science (ICEECS-2014), Chennai, Tamil Nadu, 30 March.

[4]. Zambra, D. A., Rech, C., & Pinheiro, J. R. (2010). Comparison of neutral-point-clamped, symmetrical, and hybrid asymmetrical multilevel inverters. IEEE Transactions on Industrial Electronics, 57(7), 2297- 2306.

[5]. Muhammad, T., Khan, A. U., Luqman, M., Satti, M. B., Aaqib, M., & Khan, M. F. (2015, June). Generation of isolated DC voltage sources for multilevel inverters. In 2015 Power Generation System and Renewable Energy Technologies (PGSRET) (pp. 1-6). IEEE.

[6]. Rodriguez, J., Lai, J. S., & Peng, F. Z. (2002). Multilevel inverters: a survey of topologies, controls, and applications. IEEE Transactions on industrial electronics, 49(4), 724-738.

[7]. Babaei, E., Alilu, S., & Laali, S. (2013). A new general topology for cascaded multilevel inverters with reduced number of components based on developed H-bridge. IEEE Transactions on Industrial Electronics, 61(8), 3932-3939.

[8]. E. Babaei, "Optimal topologies for cascaded sub- multilevel converters," J. Power Electron, vol. 10, no. 3, pp. 251–261, May 2010.

[9]. E. Beser, B. Arifoglu, S. Camur, and E. K. Beser, "Design and application of a single phase multilevel inverter suitable for using as a voltage harmonic source," J. Power Electron., vol. 10, no. 2, pp. 138–145, Mar. 2010.

[10]. Jih-Sheng Lai, IEEE, and Fang Zheng Peng, "A New Breed of flying Capacitor Multilevel Converter" IEEE Transactions On Industry Applications, Vol. 32, No. 3, May/June 1996.

[11]. Yun XU, Yunping ZOU, Xiong LIU, Yingjie He, "A Novel Composite Cascade Multilevel Converter", IEEE Industrial Electronics Society (IECON), Nov. 5-8, 2007.

[11]. G. M. Martins, J. A. Pomilio, S. Buso, and G. Spiazzi, "Three-phase low frequency commutation inverter for renewable energy systems," IEEE Trans. Ind. Electron., vol. 53, no. 5, pp. 1522–1528, Oct. 2006.

[12]. de Oliveira, F. M., da Silva, S. A. O., Durand, F. R., Sampaio, L. P., Bacon, V. D., & Campanhol, L. B. (2016). Grid-tied photovoltaic system based on PSO MPPT technique with active power line conditioning. IET Power Electronics, 9(6), 1180-1191.

[13]. Daher, S., Schmid, J., & Antunes, F. L. (2008). Multilevel inverter topologies for stand-alone PV systems. IEEE transactions on industrial electronics, 55(7), 2703-2712.

[14]. Tolbert, L. M., & Peng, F. Z. (1998, February). Multilevel converters for large electric drives. In APEC'98 Thirteenth Annual Applied Power Electronics Conference and Exposition (Vol. 2, pp. 530-536). IEEE.