

# SERIES ACTIVE POWER FILTER FOR POWER QUALITY IMPROVEMENT

Akash A Yergude<sup>1</sup>, Dhammaratna B Waghmare<sup>2</sup>, Chandrakala R Gowder<sup>3</sup>

<sup>1</sup> PG Scholar, Electrical Engineering Department, Shri Sai College of Engg & Tech, Bhadravati, Maharashtra, India

<sup>2</sup> Assistant Professor, Electrical Engineering Department, Shri Sai College of Engg & Tech, Bhadravati, Maharashtra, India

<sup>3</sup> Assistant Professor, Electrical Engineering Department, Shri Sai College of Engg & Tech, Bhadravati, Maharashtra, India

## ABSTRACT

These hundreds area unit sensitive for any input variations in voltage. The performance of the electrical instrumentality gets worsened if they're furnished with contaminated or distorted voltage. variety of solutions area unit offered within the gift day apply like power issue correction system with detuned filter, capacitance banks and series reactors to mitigate harmonics, improve power issue, avoid electrical resonance. Much passive filters area unit still used those they need mounted compensation and therefore the threat of resonance.

Solutions to those issues are often of 2 ways- one is to vary the look of the systems so the matter gets reduced and therefore the alternative is to seek out a remedy for the prevailing system. The various hundreds area unit classified in line with the issues raised by them and to focus on the assorted sensible solutions that may solve them to a good extent.

This paper focuses on modeling and analysis of Custom Power Device (SAPF). MATLAB/Simulink based mostly models for Series Active Power filter (SAPF) is given. Among varied PWM techniques, physical phenomenon band voltage management PWM is popularly used as a result of its simplicity of implementation. This renowned technique doesn't would like any info regarding system parameters. The SAPF is simulated for various voltage variations at input generated by the 3 part programmable supply and therefore the results area unit given.

**Keyword:** - Series Active Power Filter, Power quality

## 1. INTRODUCTION

Power quality phenomena embrace all doable things during which the wave form of the provision voltage (voltage quality) or load current (current quality) deviate from the curving wave form at rated frequency with amplitude equivalent to the rated rms price for all 3 phases of a three-phase system [1]. The wide selection of power quality disturbances covers fast, short length variations, e.g. impulsive and oscillating transients, voltage sags, short interruptions, yet as steady state deviations, like harmonics and flicker. One can even distinguish, supported the cause, between disturbances associated with the standard of the provision voltage and people associated with the standard of the present taken by the load [2].

To the primary category covers voltage dips and interruptions, principally caused by faults within the grid. These disturbances could cause tripping of "sensitive" instrumentality with fatal consequences in industrial plants wherever tripping of vital equipment will bear the stoppage of the entire production with high prices associated.

One will say that during this case it's the supply that disturbs the load. To avoid consistent cash losses, industrial customers typically conceive to install mitigation instrumentation to shield their plants from such disturbances. The second category covers phenomena thanks to caliber of this drawn by the load. During this case, it's the load that disturbs the supply. A typical example is current harmonics drawn by worrisome masses like diode rectifiers, or unbalanced currents drawn by unbalanced masses. Customers don't expertise any direct production loss associated with the incidence of those power quality phenomena. However poor quality of this taken by many purchasers along can ultimately lead to caliber of the facility delivered to alternative customers [3]. Each harmonics and unbalanced currents ultimately cause distortion and severally, unbalance within the voltage moreover.

Therefore, correct standards area unit issued to limit the number of harmonic currents, unbalance and/or flicker that a load could introduce. To fits limits set by standards, customers typically need to install mitigation instrumentation. In recent years, each industrial and business customer of utilities has reported a flood tide of misadventures associated with power quality. the difficulty stems from the multiplied refinement of today’s automatic instrumentation, whether or not variable speed drives or robots, automatic production lines or machine tools, programmable logic controllers or power provides in computers. They and therefore their like area unit way at risk of disturbances on the utility system than were the previous generation of mechanical device instrumentation and the previous less automatic production and knowledge systems. A growing range of masses is sensitive to customers’ vital processes that have pricey consequences if disturbed by either poor power quality or power interruption. For the explanations represented higher than, there’s a growing interest in instrumentation for mitigation of power quality disturbances, particularly in newer devices supported power physics referred to as “custom power devices” ready to deliver bespoke solutions to power quality issues.

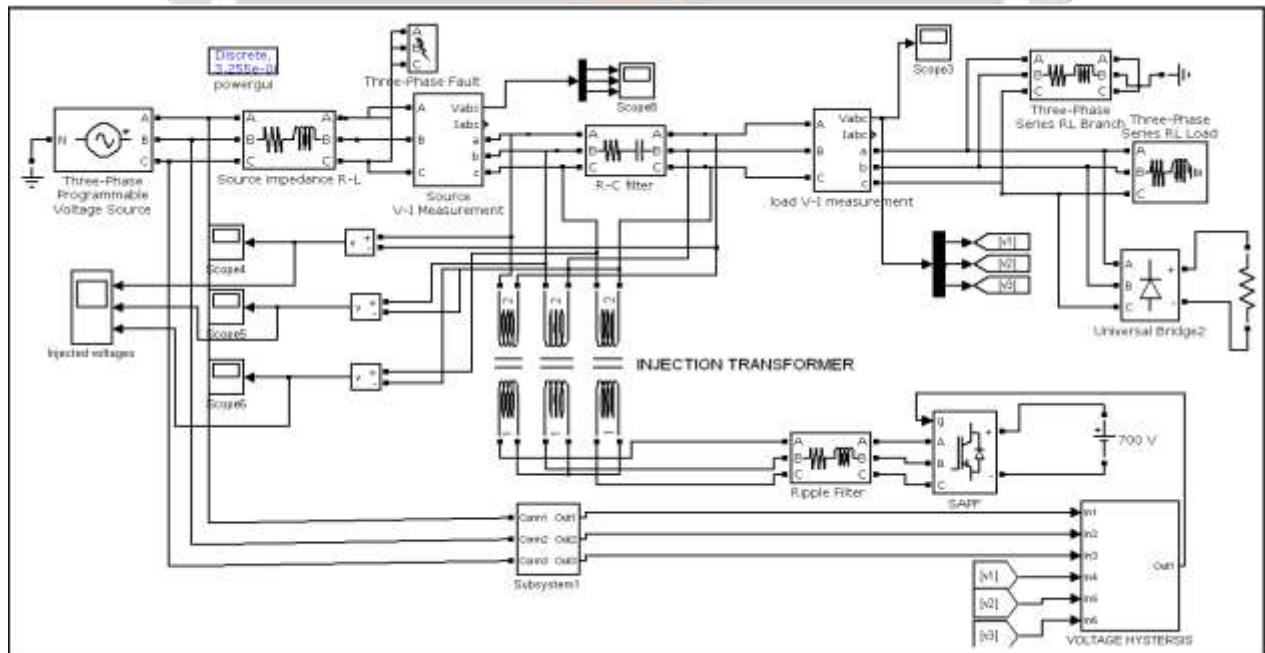
## 2. MATLAB SIMULATION MODEL

The series active power filter is employed to compensate the supply facet disturbances like voltage sags, swells and conjointly harmonic distortions. during this configuration, the filter is connected nonparallel with the road being stipendiary. Therefore the configurations square measure usually brought up as a series active filter. The approach relies on the principle of injecting voltage nonparallel with the road through the injection electrical device to cancel the supply facet voltage disturbances and so it makes the load facet voltage curving.

Fig. 1 shows the MATLAB/ Simulink model of designed system.

The main components of the below system are as follows.

- Mains supply
- Nonlinear load
- Active Power Filter
  - Voltage source inverter
  - Interface reactor
  - Reference voltage generator
  - Hysteresis voltage controller



**Fig -1:** MATLAB simulation model of proposed series active power filter

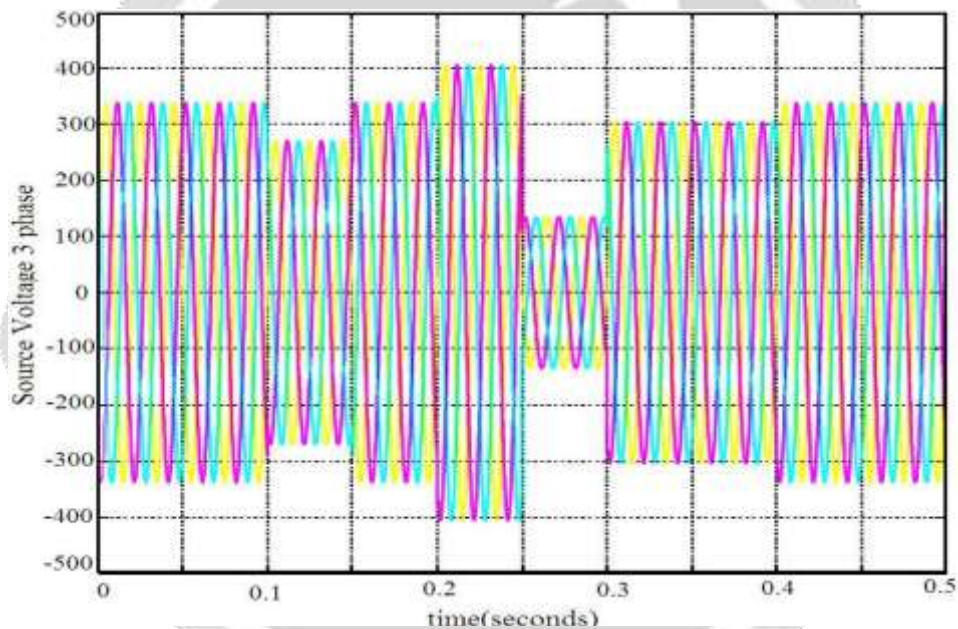
### 3. MATLAB SIMULATION RESULT

#### 3.1. Case 1 model

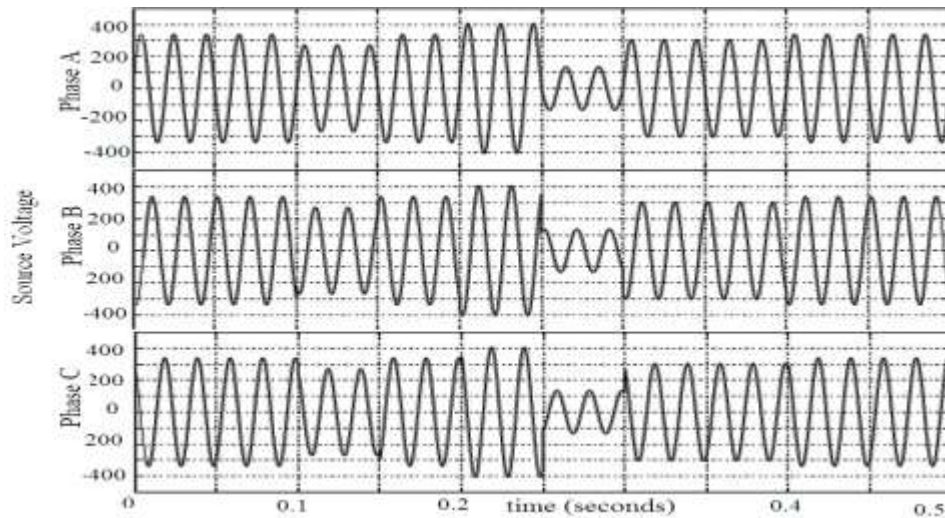
Fig. 2 shows the source voltage in which rated 1 p.u voltage is created from 0 to 0.1 seconds , 0.8 p.u sag from 0.1 to 0.15 seconds, 1 p.u voltage from 0.15 to 0.2 seconds, 1.2 p.u swell from 0.2 to 0.25 seconds , 0.4 p.u sag from 0.25 to 0.3 seconds , 0.9 sag from 0.3 to 0.4 seconds and 1p.u voltage from 0.4 to 0.5 seconds.

**Table -1:** Source Voltage parameters 3-phase (line-Ground)

Time (Second)	Voltage (pu)	Load
0 to 0.1	1	R = 50 $\Omega$ ; L = 1 mH
0.1 to 0.15	1.8	
0.15 to 0.2	1	
0.2 to 0.25	1.2	
0.25 to 0.3	0.4	
0.3 to 0.4	0.9	
0.4 to 0.5	1	

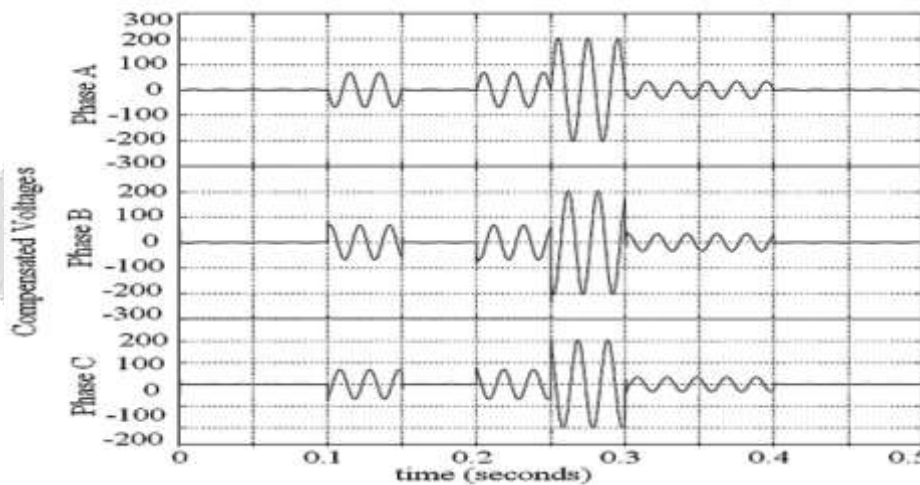


**Fig -2:** 3-Phase Source voltage (Line-Ground)



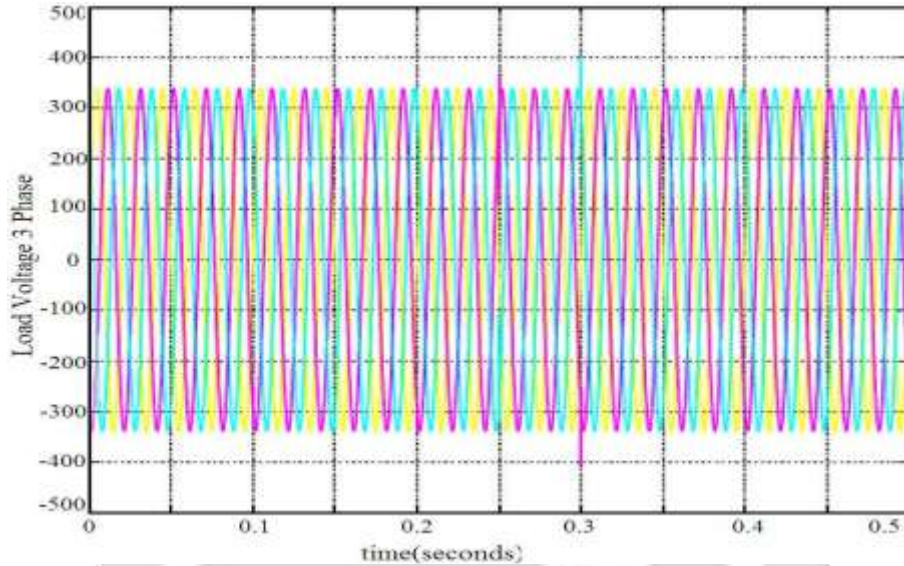
**Fig-3:** Source Voltage in each Phase

Fig. 4 shows the compensated voltage injected by each phases to cancel the source side disturbances present in the system.



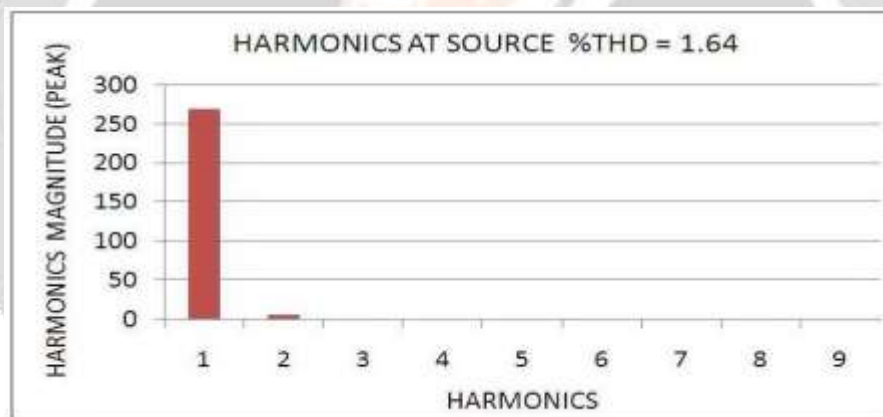
**Fig-4:** Compensated voltages injected for each phases

Due to the injection of the above voltages through the injection transformer in series with the line the load voltage is sinusoidal as shown in Fig. 5.

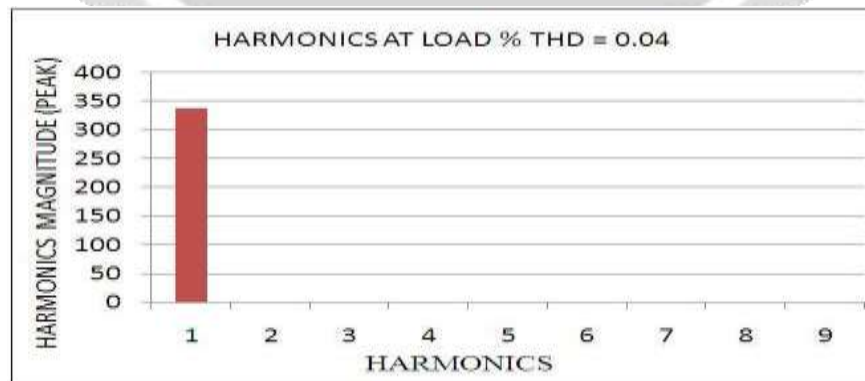


**Fig-5:** 3-Phase Load voltage (Line-Ground)

The Total harmonic distortion of source voltage is 1.64% and load voltage is 0.04 % as shown in Fig. 4.6 & Fig. 4.7 respectively.



**Fig-6:** Source voltage harmonic spectrum

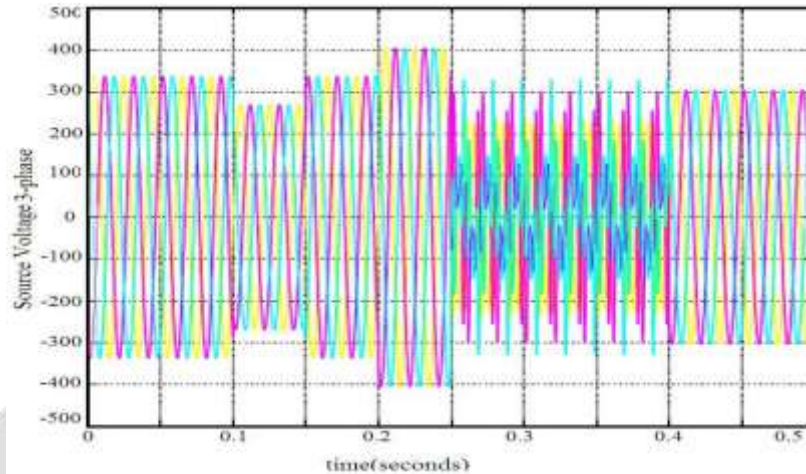


**Fig-7:** Load voltage harmonic spectrum

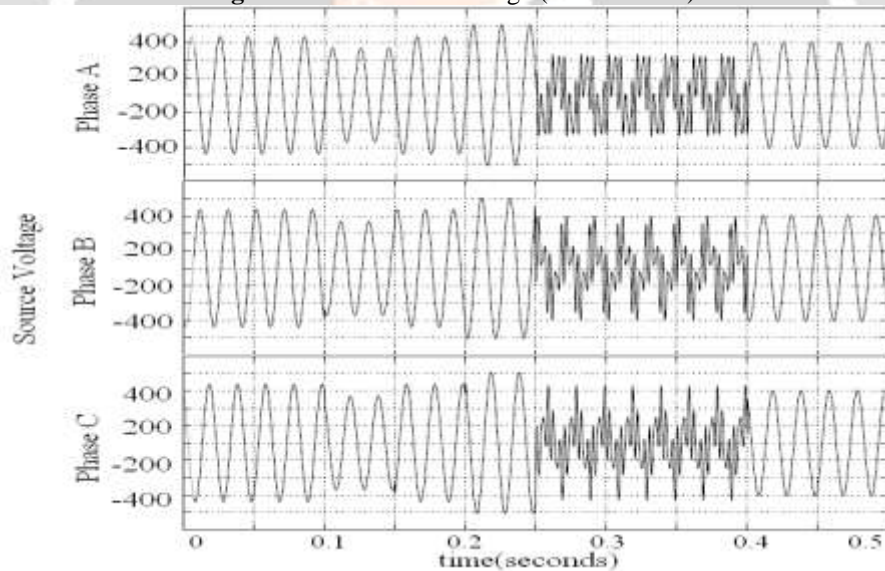
The SAPF is simulated with only interruptions in the form of Sag, Swell in the input side & the performance of SAPF is analyzed by taking the FFT analysis of the Source and load Voltages.

**3.2. Case 2 model**

Fig. 8 shows the source voltage in which rated 1 p.u voltage is created from 0 to 0.1 seconds , 0.8 p.u sag from 0.1 to 0.15 seconds, 1 p.u voltage from 0.15 to 0.2 seconds, 1.2 p.u swell from 0.2 to 0.25 seconds , 5th order harmonics of 0.4 p.u and 7th order harmonics of 0.2 p.u from 0.25 to 0.4 seconds , 0.9 sag from 0.4 to 0.5 seconds . the load is  $R=50\Omega$  and  $L=10\text{ mH}$ .

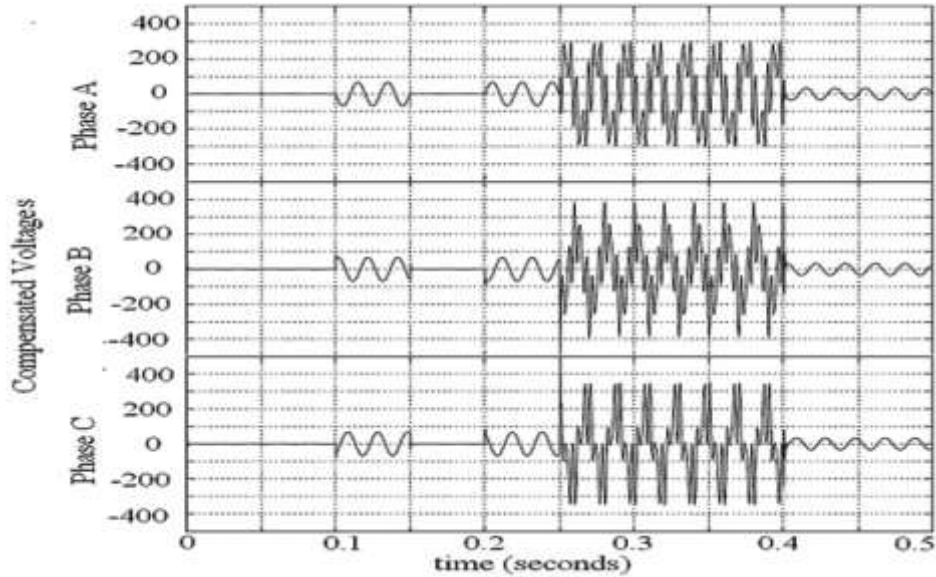


**Fig-8:** 3-Phase Source voltage (Line-Ground)



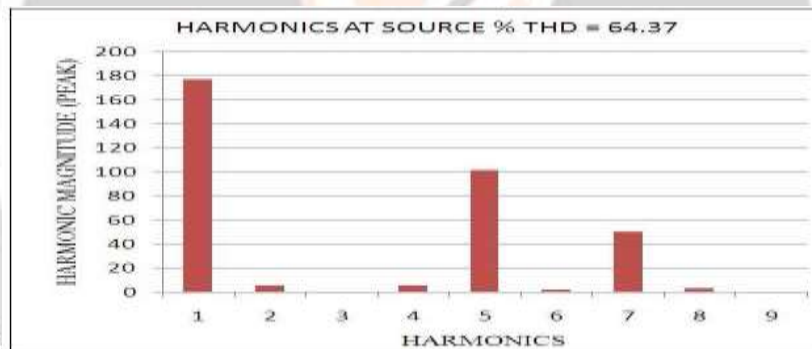
**Fig-9:** Source Voltages per phase

Fig. 10 shows the compensated voltage injected by each phases to cancel the source side disturbances present in the system.

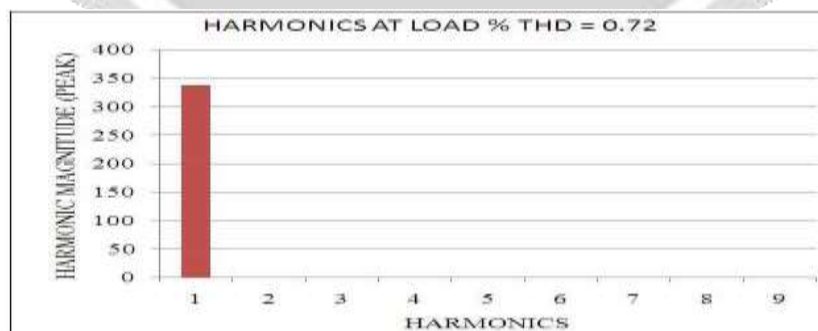


**Fig-10:** Compensated voltages injected for each phases

Due to the injection of the above voltages through the injection transformer in series with the line the load voltage is sinusoidal. The Total harmonic distortion of source voltage is 64.37% and load voltage is 0.72 % as shown in Fig. 11 & Fig. 12 respectively.



**Fig-11:** Source voltage harmonic spectrum



**Fig-12:** Load voltage harmonic spectrum

**4. CONCLUSION**

A Series active power filter has been investigated for power quality improvement. Numerous simulations area unit administrated to research the performance of the system. Physical phenomenon controller primarily based Series

active power filter is enforced for harmonic and voltage distortion compensation of the non-linear load. The Simulation is even extended for abnormal faults occurring on the ability system like L-G & L-L faults. This section presents an summary of series active filter, its principle of operation and its management theme to come up with reference load voltage and physical phenomenon voltage controller to administer pulses to the series filter to inject the voltage through electrical device asynchronous with the road and also the simulation waveforms for supply voltage, salaried voltage and cargo voltage area unit planned. The doctor's degree of the load voltage with the inclusion of the active filter is well below five-hitter that is that the harmonic limit obligatory by the IEEE 519 standards.

## 5. REFERENCES

- [1] Bhim Singh and venkateswarlu.P, "A Simplified Control Algorithm for Three- Phase, Four-Wire Unified Power Quality Conditioner" Journal of Power Electronics, Vol. 10, No. 1, January 2010 pp.91-96.
- [2] B.Singh,K.Al-Haddad,and A.Chandra, "A review of active power filters for power quality improvement," IEEE Trans.Ind.Electron.,vol.45,no.5,pp.960- 971,Oct 1999.
- [3] V.Khadkikar,A.Chandra,A.O.Barry,and T.D.Nguyen, "Application of UPQC to protect a sensitive load on a polluted distribution network," in Proc. IEEE PES General Meeting,Montreal,QC,Canada,2006,6pp.
- [4] V.Khadkikar ,A.Chandra,A.O.Barry,and T.D.Nguyen, "Conceptual analysis of unified power quality conditioner(UPQC)," in proc. IEEE ISIE,2006,pp.1088- 1093.
- [5] Vinod Khadkikar and Ambrish Chandra, "A Novel Structure for Three-Phase Four-Wire Distribution System Utilizing Unified Power Quality Conditioner (UPQC)" IEEE Transactions on Industry Appl., Vol. 45, No. 5, September/October 2009.
- [6] Yash Pal, A. Swarup, and Bhim Singh, " A Comparison of Three Topologies of Three-Phase Four-Wire UPQC for Power Quality Improvement" 16<sup>th</sup> National Power systems conference, 15th-17th December, 2010 pp.227-232.
- [7] S. Chakraborty and F. A. Farret, " A Single Phase High Frequency AC Microgrid with an Unified Power Quality Conditioner," Proceedings on IEEE 2003, pp.952-967.
- [8] Active power filter with automatic control circuit for neutral current harmonic minimization technique by mohd izhar bin a bakar
- [9] Handbook of Power Quality by Angelo Baghini.
- [10] S.K. Jain, P. Agrawal and H.O. Gupta, "Fuzzy logic controlled shunt active power filter for power quality improvement"IEEE Proceedings on Elect.Power.Appl.Vol 149.No.5,September 2002.